



Installation
&
Operation Manual

Index

1 Notes on this manual

- 1.1 Validity
- 1.2 Applicable personnel
- 1.3 Symbols in this document

2 Safety

- 2.1 Product description and features
- 2.2 Qualification of skilled person
- 2.3 Safety instruction

3 Product overview

- 3.1 Appearance overview
- 3.2 Dimensions
- 3.3 Storage environment

4 Unpacking inspection

5 Installation

- 5.1 Basic installation requirements
- 5.2 Mounting wall mount
- 5.3 Installing the inverter

6 Inverter wiring

- 6.1 Security
- 6.2 AC side wiring
- 6.3 DC side wiring
- 6.4 Connecting the Bidirectional DC/DC Box
- 6.5 Connect the signal cable
- 6.6 Grounding the inverter
- 6.7 Active power control with smart meter, CT or ripple control signal receiver
- 6.8 Inverter demand response modes (DRMS)
- 6.9 GFCI(Standard)
- 6.10 AFCI(Optional)
- 6.11 Backup(optional)

7 Debugging

8 Working mode

- 8.1 Normal mode
- 8.2 Failure mode
- 8.3 Shutdown mode

9 OLED display and touch buttons

- 9.1 Boot display
- 9.2 OLED display wake up
- 9.3 Function setting

10 Communication and monitoring

- 10.1 COM port
- 10.2 USB-A

11 Maintenance and Cleaning

- 11.1 Checking heat dissipation
- 11.2 Cleaning the inverter
- 11.3 Checking the DC disconnect

12 Start the inverter and shut down the inverter

- 12.1 Start the inverter
- 12.2 Shut down the inverter

13 Troubleshooting

- 13.1 Error message
- 13.2 System error

14 Manufacturer warranty

15 Decommissioning

- 15.1 Dismantling the inverter
- 15.2 Packing the inverter
- 15.3 Storing the inverter
- 15.4 Disposing of the inverter

16 EU declaration of conformity

17 Specification

- 17.1 Specification
- 17.2 Torque
- 17.3 Annex

18 EU declaration of conformity

19 Contact us

1 Notes on this manual

1.1 Validity

This manual will provide detailed product information and installation instructions for users of MOD TL3-XH series photovoltaic inverter of Shenzhen Growatt new energy Co., Ltd. (hereinafter referred to as Growatt new energy). Please read this manual carefully before using this product. Growatt new energy will not inform users of any changes to this manual.

MOD 3000TL3-XH
MOD 4000TL3-XH
MOD 5000TL3-XH
MOD 6000TL3-XH
MOD 7000TL3-XH
MOD 8000TL3-XH
MOD 9000TL3-XH
MOD 10KTL3-XH
MOD 10KTL3-XH BE

1.2 Applicable personnel



The inverter must be installed by professional electricians who are certified by relevant departments. By reading this manual in detail, the installer can install the MOD 3-10K XH series inverter correctly and quickly, and can carry out troubleshooting and communication system construction.



If there are any problems during the installation process, the installer can log on to www.growatt.com to leave a message on the website or call our 24-hour service phone: +86 755 2747 1942.

1.3 Symbols in this document











1.3.1 Symbols in this document

Warnings indicate hazards to equipment or personnel. It draws your attention to a certain procedure or practice. If the procedure or practice is not properly implemented or followed, it may cause damage or destruction of part or all of the Growatt device and/or other equipment connected to the Growatt device, or cause personal injury.

Symbol	Description
 DANGER	DANGER indicates a hazardous situation which, if not avoided, will result in death or serious injury.
 WARNING	WARNING indicates a hazardous situation which, if not avoided, could result in death or serious injury.
 CAUTION	CAUTION indicates a hazardous situation which, if not avoided, could result in minor or moderate injury.

 NOTICE	NOTICE is used to address practices not related to personal injury.
 Information	Information that you must read and know to ensure optimal operation of the system.

1.3.2 Markings on this product

Symbol	Explanation
	Danger: Electricity!
	Danger:Flame!
	Danger:Hot surface!
	Operation after 5 minutes
	Point of connection for grounding protection
	Direct Current (DC)
	Alternating Current (AC)
	Read the manual
	CE mark. The inverter complies with the requirements of the applicable CE guidelines.
	The inverter must not be disposed of with the household waste.

1.3.3 Glossary

AC

Abbreviation for "Alternating Current"

DC

Abbreviation for "Direct Current"

Energy

Energy is measured in Wh (watt hours), kWh (kilowatt hours) or MWh (megawatt hours). The energy is the power calculated over time. For example, your inverter operates at a constant power of 4600 W for half an hour and then at a constant power of 2300 W for another half an hour, it has fed 3450Wh of energy into the power distribution grid within that hour.

Power

Power is measured in W (watts), kW (kilowatts) or MW (megawatts). Power is an instantaneous value. It displays the power your inverter is currently feeding into the power distribution grid.

Power rate

Power rate is the ratio of current power feeding into the power distribution grid and the maximum power of the inverter that can feed into the power distribution grid.

Power factor

Power factor is the ratio of active power or watts to apparent power or volt amps. They are identical only when current and voltage are in phase then the power factor is 1.0. The power in an ac circuit is very seldom equal to the direct product of the volts and amperes. In order to find the power of a single phase ac circuit the product of volts and amperes must be multiplied by the power factor.

PV

Abbreviation for photovoltaic.

Wireless communication

The external wireless communication technology is a radio technology that allows the inverter and other communication products to communicate with each other. The wireless communication device is not standard. Require to order extra if you need it.

2.1 Product description and features

2.1.1 Product description

Growatt series photovoltaic inverters are used to convert the direct current generated by photovoltaic panels into alternating current, and send it to the grid in a three-phase manner. Growatt MOD 3-10K TL3-XH series inverter can be connected to 2 strings, has 2 maximum power tracking point trackers, so suitable for connection 2 set of arrays of different panels.

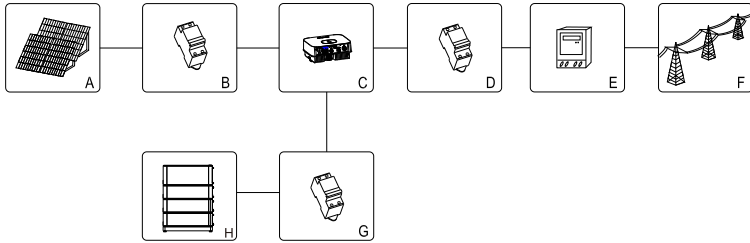

Fig 2.1

Position	Description
A	Solar panel
B	DC circuit breaker
C	Inverter
D	AC circuit breaker
E	Electric energy meter
F	Utility grid
G	DC circuit breaker
H	Battery matched with XH inverter

As shown in Fig 2.1 above, a complete photovoltaic Battery System includes photovoltaic modules, photovoltaic inverters, public grids and other components. In the photovoltaic module system, the photovoltaic inverter is a key component.

Note: If the selected photovoltaic module requires positive or negative grounding, please contact Growatt for technical support before installation.

2.1.2 Product features

The characteristics of the inverter are as follows:

- Dual independent maximum power point tracking
- Built-in DC switch
- Compatible with RS485/Wifi/GPRS/4G communication
- 140V-1100V input Voltage range
- The maximum efficiency is as high as 98.6%
- OLED+LED/WIFI+APP display
- Integrated with touch button
- Protection grade Ip66
- The weight is only 14kg

- Simple installation
- Integrated with energy storage and backup functions
- Integrated with phase-level export limitation function
- Integrated with AC power supply function
- Integrated with energy storage one-key detection function
- Integrated with AC power supply function to realize the 24h self-consumption monitoring

2.2 Qualification of skilled person

This grid-tied inverter system operates only when properly connected to the AC distribution network. Before connecting the MOD 3-10K TL3-XH to the power distribution grid, contact the local power distribution grid company. This connection must be made only by qualified technical personnel to connect, and only after receiving appropriate approvals, as required by the local authority having jurisdiction.

2.3 Safety instructions



1. Please read this manual carefully before installation. If you fail to install according to the instructions in this manual, or ignore the warnings in the manual and the equipment is damaged, our company reserves the right not to guarantee the quality;
2. All operations and wiring should be finished by the professional electrical or mechanical engineers;
3. During installation, except for the wiring terminals, please do not move other parts inside the chassis;
4. All electrical installations must comply with local electrical safety standards;
5. If the machine needs maintenance, please contact the local designated system installation and maintenance personnel;
6. The use of this machine for grid-connected power generation requires permission from the local power supply department;
7. When installing photovoltaic modules during the day, use opaque materials to cover the photovoltaic modules, otherwise the voltage at the module terminals will be high in the sun, which may cause personal danger.

2.3.1 Assembly Warnings



 WARNING	<ul style="list-style-type: none"> ➤ Before installation, please check the unit to ensure that there is no transportation or handling damage, which may affect the insulation integrity or safety clearances; otherwise, it may cause safety hazards. ➤ Follow the instructions in this manual to assemble the inverter. Note that select the suitable mounting location and comply with the specified requirements of cooling. ➤ Unauthorized removal of necessary protections, improper use, incorrect installation and operation may lead to serious safety and shock hazards and/or equipment damage. ➤ In order to minimize the possibility of shock hazards due to dangerous voltages, cover the entire solar array with dark colored materials before connecting the array to any equipment.
---	---

 <p>CAUTION</p>	<ul style="list-style-type: none"> ➤ Grounding the PV modules: MOD 3-10K TL3-XH is a transformerless inverter. which means there is no galvanic separation. Do not grounding the DC side of the MOD TL3-XH inverter. Only grounding the mounting frame of the photovoltaic module. Otherwise there will be an error message "PV ISO Low". ➤ Comply with the local requirements for grounding the PV modules and the PV generator. GROWATT recommends connecting the generator frame and other electrically conductive surfaces in a manner which ensures continuous conduction with ground in order to have optimal protection of the system and personnel.
--	---

2.3.2 Electrical Connection Warnings

 <p>DANGER</p>	<ul style="list-style-type: none"> ➤ The components in the inverter are live. Touching live components can result in serious injury or death. <ul style="list-style-type: none"> • Do not open the inverter except the wire box by qualified persons. • Electrical installation, repairs and conversions may only be carried out by electrically qualified persons. • Forbid live line work. ➤ Danger to life due to high voltages in the inverter <ul style="list-style-type: none"> • There is residual voltage in the inverter after the device shutdown. The inverter need to take 20 minutes to discharge for safety. ➤ Persons with limited physical or mental abilities may only work with the Growatt inverter following proper instruction and under constant supervision. Must keep the Growatt inverter away from children.
 <p>WARNING</p>	<ul style="list-style-type: none"> ➤ Make all electrical connections (e.g. conductor termination, fuses, PE connection, etc.) in accordance with prevailing regulations. When using the inverter to provide the power, adhere to all prevailing safety regulations to minimize risk of accidents. ➤ Systems with inverters typically require additional control (e.g., switches, disconnects) or protective devices (e.g., fusing circuit breakers) depending upon the prevailing safety rules.

2.3.3 Operation Warnings

 <p>WARNING</p>	<ul style="list-style-type: none">➤ Ensure all connectors are sealed and secure during operation.➤ Although designed to meet all safety requirements, some parts and surfaces of inverter are still hot during operation. To reduce the risk of injury, do not touch the heat sink at the back of the PV-inverter or nearby surfaces while inverter is operating.➤ Incorrect sizing of the PV panels may result in voltages being present which could destroy the inverter. The inverter display will read the error message "PV voltage High!"
 <p>CAUTION</p>	<ul style="list-style-type: none">➤ All operations regarding transport, installation and start-up, including maintenance must be operated by qualified, trained personnel and in compliance with all prevailing codes and regulations.➤ When the inverter is disconnected from the grid, please be careful because some components can retain enough charge to create a shock hazard. In order to minimize the occurrence of this situation, observe all corresponding safety symbols and marks in this manual.➤ Under special circumstances, the inverter may be subject to electromagnetic interference from surrounding equipment. At this time, the user is obliged to take correct measures to reduce the interference from surrounding equipment to the inverter.➤ Do not stay close to the inverter less than 20cm at any time.

Product overview 3

3.1 Appearance overview

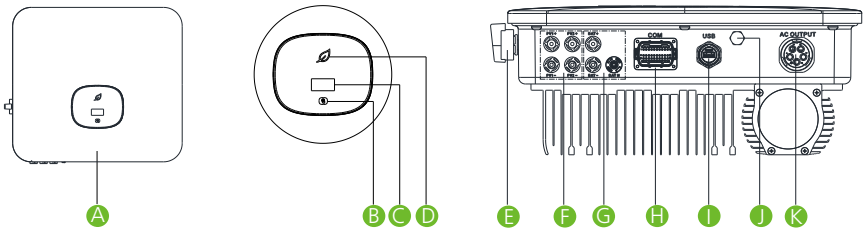



Fig 3.1

The appearance instructions are as follows:

No.	Name	No.	Name	No.	Name
A	Front panel	E	DC switch	I	USB port
B	Touch button	F	PV terminal	J	Vent valve
C	OLED screen	G	Battery terminal	K	AC terminal
D	LED indicator	H	COM port		

The label description on the inverter:

Symbol	Description	Explanation		
	Touch symbol	Touch button. We can switch the OLED display and set parameter by touching.		
	Inverter status symbol	Inverter status	LED color	LED status
		Standby	Green	0.5S on and 2S off
		Normal	Green	Solid
		Fault	Red	Solid
		Inverter warning/Battery fault	Green	0.5s on, 0.5s off/0.5s on, 2s off
		Inverter status	Yellow	1s on and 1s off

3.2 Dimensions

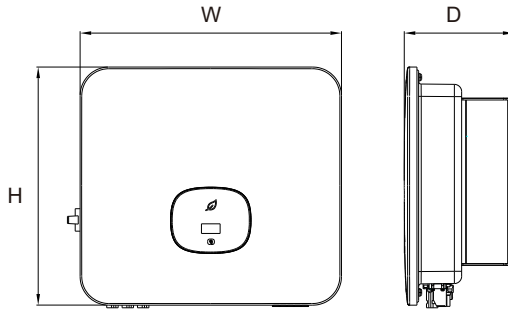

Fig 3.2

Size and weight:

Model	Height (H)	Width (W)	Depth (D)	Weight
MOD 3-6KTL3-XH	387mm	425mm	147mm	13kg
MOD 7-10KTL3-XH	387mm	425mm	178mm	14kg

3.3 Storage Environment

If you want to store the inverter in a warehouse, you must choose a suitable location for the inverter.

- The equipment must be stored in its original packaging.
- The storage temperature should always be between -25°C and $+60^{\circ}\text{C}$, and the storage relative humidity should be less than 90%.
- If you need to store a batch of inverters, the maximum number of layers of the original carton is 4.

Unpacking inspection 4

Before opening the inverter package, please check whether the outer package is damaged. After unpacking, please check whether the appearance of the inverter is damaged or lack of accessories. If there is damage or missing parts, please contact the dealer.

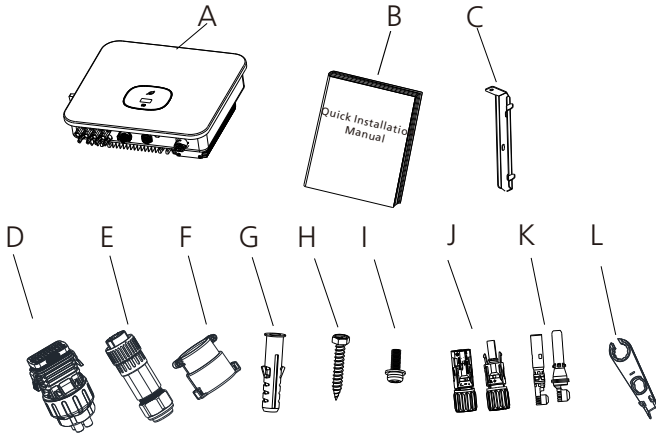

Fig 4.1

No.	Description	Qty.
A	Inverter	1
B	Quick Installation Manual	1
C	Wall bracket	1
D	COM port connector	1
E	AC connector	1
F	AC connector shell	1
G	Plastic expansion tube	3
H	Expansion screw	3
I	Security screw	1
J	PV terminal shell	2/2
K	PV terminal core	2/2
L	PV terminal removal tool	1

5 Installation

5.1 Basic installation requirements

- The wall on which the inverter is mounted must be sturdy and can withstand the weight of the inverter for a long time (refer to the specifications in Chapter 17 for the weight of the inverter);
 - The installation location must match the size of the inverter;
 - Do not install the inverter on a building constructed of flammable or heat-resistant materials;
 - Install the inverter in an eye-view orientation to facilitate inspection of the OLED display and maintenance work;
 - The machine's degree of protection is IP66 and can be installed indoors and outdoors;
 - It is not recommended to expose the inverter directly to strong sunlight to prevent overheating and cause power derating;
 - The humidity of the installation environment should be between 0 and 90%;
 - The ambient temperature around the inverter should be between $-25^{\circ}\text{C} \sim 60^{\circ}\text{C}$;
 - The inverter can be mounted on a plane that is tilted vertically or backwards.
- Please refer to the following figure:

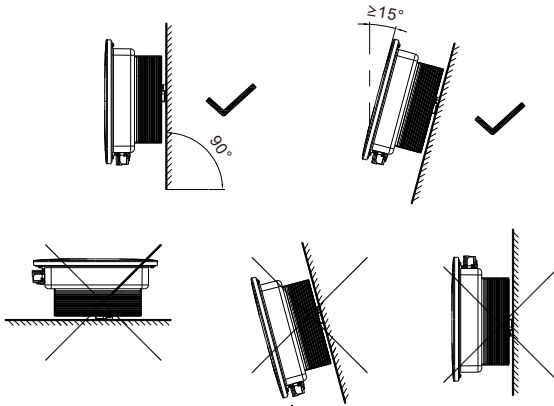

Fig 5.1 Installation diagram

- In order to ensure the normal operation of the machine and the convenience of personnel operation, please pay attention to provide sufficient clearance for the inverter. Please refer to the figure below:

Direction	Minimum clearance (mm)
Above	500
Under	500
Both sides	300
Forward	300

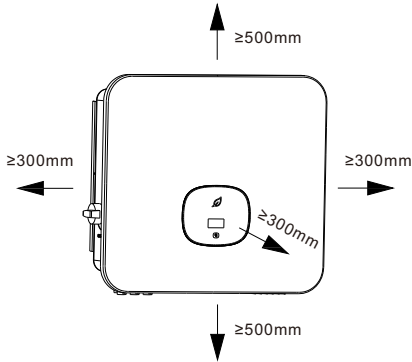

Fig 5.2 Installation dimensions for one inverter

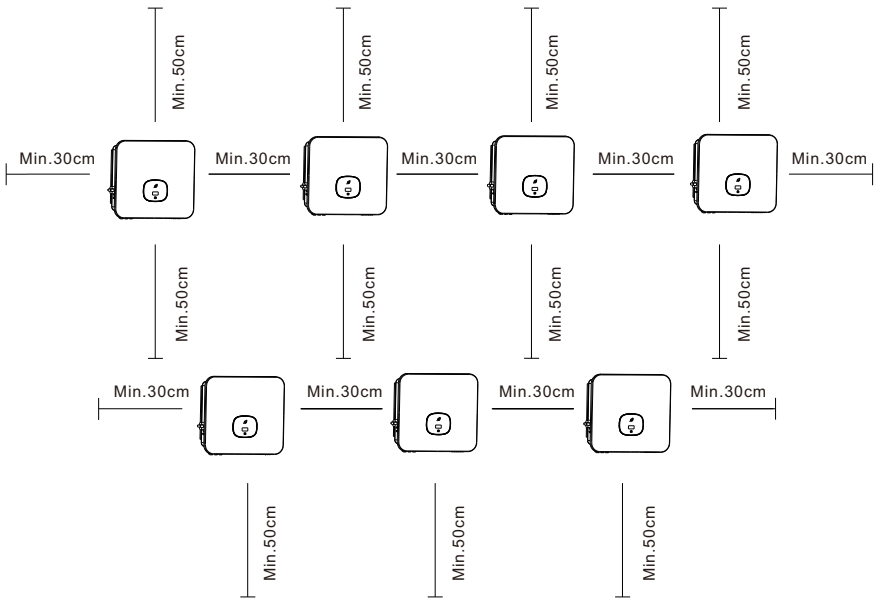

Fig 5.3 Installation dimensions for multiple inverters

- Do not install the inverter on the TV antenna, other antennas or antenna cables;
- Do not install the inverter in the living area;
- Do not install the inverter where children can reach it;
- The inverter should be installed in a sheltered and protected location such as cool, rain-proof;

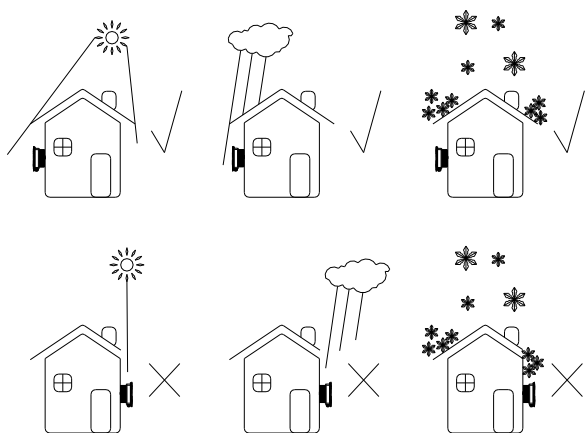

Fig 5.4 Installation Environment

- Make sure that the inverter is installed in a suitable place and is not allowed to be installed in a closed box;

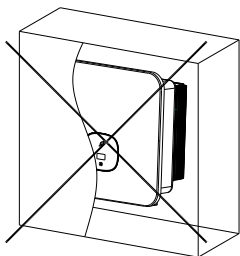

Fig 5.5 Closed box

- In order to reduce the inverter load and extend the life of the inverter due to direct sunlight, we recommend installing a awning. The distance between the awning and the inverter is as follows:

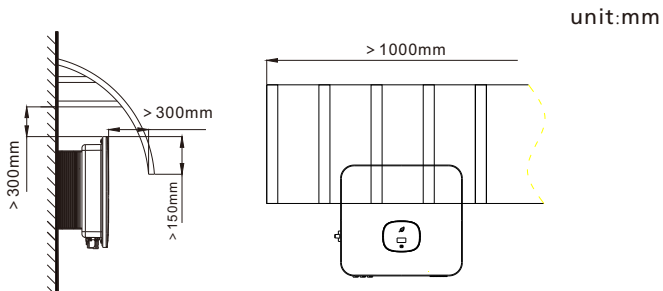



Fig 5.6 Sunshade

5.2 Install the wall mount

5.2.1 Install the wall mount

 <p>DANGER</p>	To prevent electric shock or other damage, be sure to check the wall for power or other piping before opening the hole in the wall.
---	---

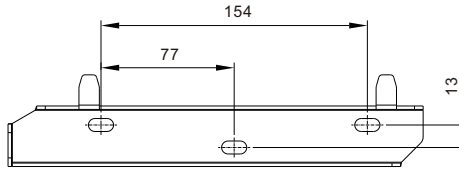

Fig 5. 7 Specifications of wall mount

Secure the wall mount as shown, do not let the screws flush with the wall, instead expose 2 to 4 mm.

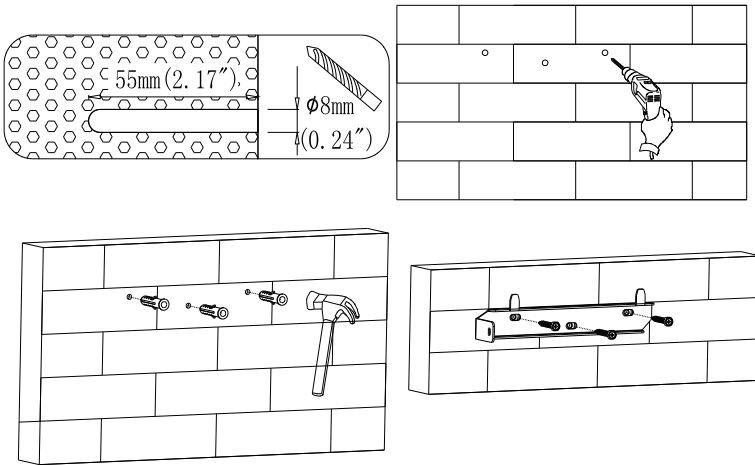

Fig 5.8 Schematic diagram of wall mount installation

5.3 Installing the inverter

Note: Before installing the inverter, you must first make sure that the wall mount is firmly fixed to the wall.

steps:

1. Hang the inverter on the wall mount and keep the inverter balanced when hanging.
2. To ensure that the inverter can be securely attached to the wall, secure the side of the inverter with the M5 safety screw on the left.

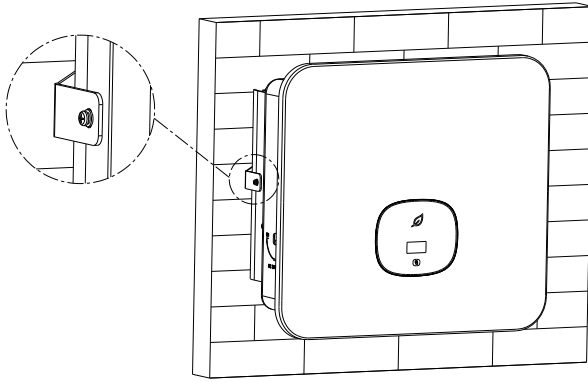







Fig 5.9 Schematic diagram of inverter wall mounting

Inverter wiring 6

6.1 Security

 DANGER	There may be a high voltage in the conductive part of the inverter, which may cause electric shock. Therefore, when installing the inverter, make sure that the AC and DC sides of the inverter are powered off.
 WARNING	Static electricity may damage the electronic components of the inverter. Anti-static measures should be taken during the replacement or installation of the inverter.
 NOTICE	Moisture and dust penetration can damage the inverter ➤ Make sure that the waterproof cable gland is firmly tightened. ➤ If the cable connector is not installed correctly, the inverter may be damaged due to the penetration of moisture and dust. All warranty claims are void

6.2 AC side wiring

 DANGER	Before making electrical connections, please make sure that the DC switch of the inverter is in the "OFF" state and disconnect the AC side MCB, otherwise the high voltage of the inverter may cause death.
 WARNING	<ul style="list-style-type: none">➤ Each inverter must be installed with an AC circuit breaker independently, and it is forbidden to share multiple inverters.➤ It is forbidden to use single-core wire at the output terminal of the inverter.➤ It is forbidden to use aluminum wires as output cables.➤ Please ensure that the output cable is well connected before turning on the inverter. Ignoring the above warning may damage the machine or cause other losses. In this case, the company reserves the right not to carry out the warranty and bear any responsibility and related expenses.
 NOTICE	Moisture and dust penetration can damage the inverter. ➤ Make sure the cable connector is securely tightened. ➤ If the cable connector is not installed correctly, the inverter may be damaged by moisture and dust. All warranty claims are invalid.

You must install a separate three phase circuit-breaker or other load disconnection unit for each inverter in order to ensure that the inverter can be safely disconnected under load.

We suggest you choose the AC breaker rating current in this table:

Inverter model	Switch specification
MOD 3000TL3-XH	10A(230/400V)
MOD 4000TL3-XH	10A(230/400V)
MOD 5000TL3-XH	15A(230/400V)
MOD 6000TL3-XH	15A(230/400V)
MOD 7000TL3-XH	15A(230/400V)
MOD 8000TL3-XH	20A(230/400V)
MOD 9000TL3-XH	20A(230/400V)
MOD 10KTL3-XH/XH BE	20A(230/400V)

Residual current protection device (RCMU)

Because the inverter itself has a high-precision residual current detection device, it is not recommended to install a leakage protection switch in the system. If for some special reason, it must be installed between the inverter output and the grid. Please install a type A leakage protection switch no less than 300mA. When multiple leakage protection switches are installed in the system, it is forbidden to share the neutral line, otherwise the leakage protection function may be triggered by mistake and cause the switch to trip.

AC connection steps :

1. Pass the 5 wires (A,B,C,N and PE wires) through the AC shield, crimp the O/U terminal and connect to the screw terminals on the AC connector.

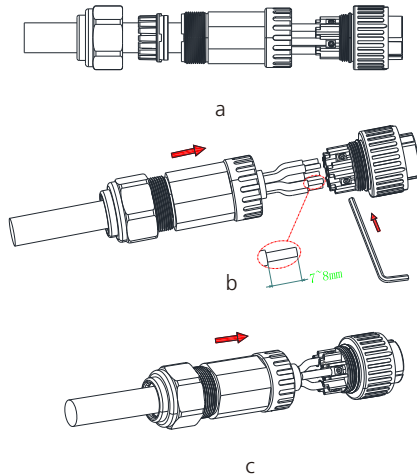

Fig 6.2 AC output wiring diagram

2.Lock the AC cable to the corresponding AC terminal.

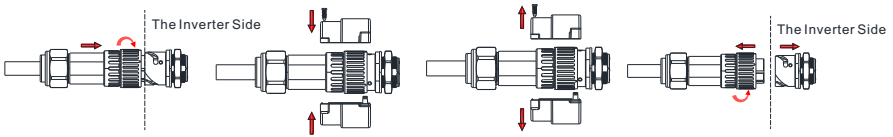

Fig 6.3 Wiring diagram of AC terminal

3. Lock the protective cover on the inverter frame, and finally tighten the protective cover hole.

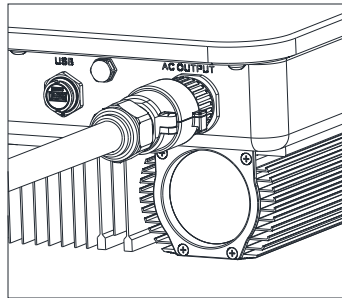





Fig 6.4 AC quick connection diagram

Suggested line length:

Model	Wire rross-sectional area(Cu)	Maximum wire length
MOD 3-6KTL3-XH	6-8mm ²	40m
MOD 7-10KTL3-XH	6-10mm ²	30m

6.3 DC side wiring

 DANGER	<ul style="list-style-type: none"> ➤ Sunlight will generate voltage on the PV panel.The high voltage after the series connection may cause life danger.Therefore, before connecting the DC input cable,you need to cover the battery panel with an opaque material before operation, and ensure the reverse The DC switch of the inverter is in the " OFF " state, otherwise the high voltage of the inverter may cause life danger. ➤ To avoid electric shock, do not touch the live parts,and connect the terminals carefully. ➤ Please make sure that the AC switch has been disconnected before wiring.
--	--

 <p>WARNING</p>	<p>Please ensure that the following conditions are met, otherwise it may cause a fire hazard or damage the inverter. In this case, the company does not carry out quality assurance and assumes any responsibility.</p> <ul style="list-style-type: none"> ➤ The maximum open circuit voltage of each string of photovoltaic modules shall not exceed 1100Vdc under any conditions. ➤ PV modules connected in series in each PV string are of the same specification type. ➤ The maximum short-circuit current of each PV string must not exceed 26A under any conditions. ➤ The total output power of all PV strings must not exceed the maximum input power of the inverter. ➤ The negative port of the PV panel mustn't be grounded when there is no isolation transformer(the inverter output is connected to the grid directly). ➤ If a stable non-zero DC voltage is measured between the positive pole of the photovoltaic string and the ground,it means that an insulation fault has occurred at a certain position in the photovoltaic string.You need to ensure that the fault is repaired before continuing the wiring.
 <p>NOTICE</p>	<p>Moisture and dust penetration can damage the inverter.</p> <ul style="list-style-type: none"> ➤ Make sure that the waterproof cable gland is firmly tightened. ➤ If the cable connector is not installed correctly,the inverter may be damaged due to the penetration of moisture and dust.All warranty claims are void.

The MOD series inverter has two independent inputs, as shown in the figure below:

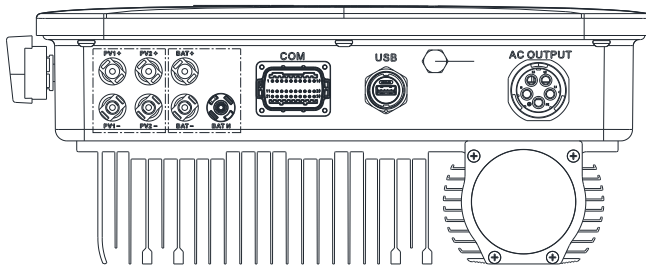



Fig 6.5

The following points should be concerned when choosing photovoltaic modules:

- The photovoltaic modules of each photovoltaic string are of the same specification and model.

 NOTICE	<ul style="list-style-type: none"> ➤ Before connecting the PV panel, please make sure that the DC input polarity is correct, that is, the positive pole of the photovoltaic module is connected to the DC input terminal marked "+" of the inverter, and the negative pole is connected to the DC input terminal marked "-". ➤ The maximum DC input current and voltage of the inverter shall not exceed the following limits. 		
	Model	Single maximum input current	Maximum input voltage
	MOD 3-10KTL3-XH	16A/16A	1100V

Connect DC terminal

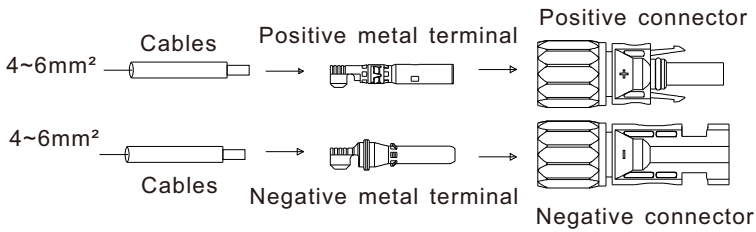

Fig 6.6

6.4 Connecting the Bidirectional DC/DC Box

6.4.1 Conditions for Bidirectional DC/DC Box

The MOD 3-10KTL3-XH three-phase inverter has one independent BAT input : BAT+/BAT- connecting to the output of Bidirectional DC/DC Box.

Notice that the connectors are in paired (male and female connectors). The connectors for Bidirectional DC/DC Box and inverters are Helios H4-R/VP-D4/MC4 connectors;

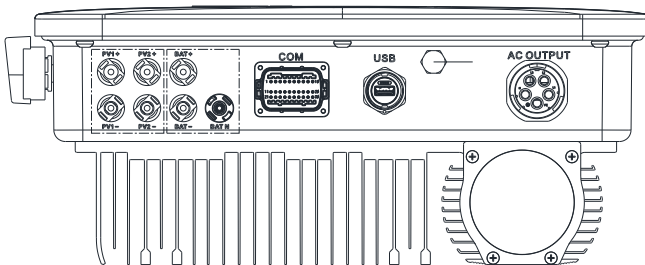



Fig 6.7

6.4.2 Connecting the Bidirectional DC/DC Box

 <p>DANGER</p>	<p>Danger to life due to lethal voltages! Before connecting the Bidirectional DC/DC Box, ensure that the Box do not connect any power supply. NEVER connect or disconnect the BAT connectors under load. Forbidden to reverse the positive and negative poles of the Bidirectional DC/DC Box and the inverter.</p>
 <p>WARNING</p>	<p>Improper operation during the wiring process can cause fatal injury to operator or unrecoverable damage to the inverter. Only qualified personnel can perform the wiring work.</p>

Connection of BAT input terminal

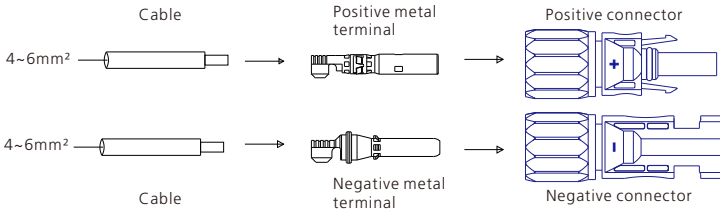

Fig 6.8

6.5 Connect the signal cable

The MOD series inverter has an 30-Pin signal connector except Vietnam models. The client signal line port is as follows:

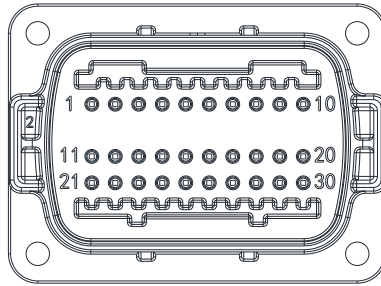

Fig 6.9

1.Strip the cable 10mm through the waterproof gland, thread sleeve, and tighten the screws.

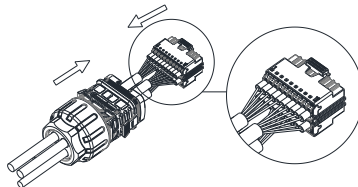

Fig 6.10

3. Connect the client to the inverter plug until both are tightly locked on the inverter.

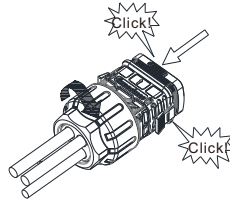

Fig 6.11

Remove the signal connector

1. Press down the fastener and pull it out of the inverter.

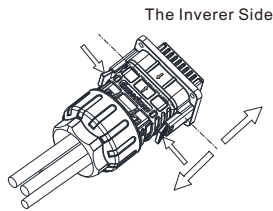

Fig 6.12

6.6 Grounding the inverter

The inverter must be connected to the AC grounding conductor of the power distribution grid via the ground terminal (PE) .



WARNING

Because of the transformerless design, the DC positive pole and DC negative pole of PV arrays are not permitted to be grounded. This inverter complies with IEC 62109-2 clause 13.9 for earth fault alarm monitoring.

If an Earth Fault Alarm occurs, the fault code "Error 303,NE abnormal" will be displayed on the inverter screen while the LED indicator red will light up. (Applicable to inverters with graphical display only)

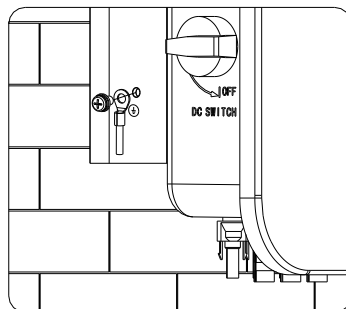



Fig 6.13

According to the relevant provisions of IEC 61643-32 "Connecting to photovoltaic devices surge protectors - selection and use of guidelines", whether for household or commercial photovoltaic power plants, it is necessary to ensure the implementation of lightning protection measures for photovoltaic systems:

 WARNING	<p>The lightning protection measures for photovoltaic systems shall be carried out in accordance with the corresponding national standards and IEC standards. Otherwise, photovoltaic devices such as components, inverters and power distribution facilities may be damaged by lightning.</p> <p>In this case, the company does not carry out warranty and assumes any responsibility.</p>
---	---

6.7 Active power control with smart meter , or ripple control signal receiver

 Information	<ul style="list-style-type: none"> ➤ The position of export limitation Meter must between the Inverter & Load and grid. ➤ The wiring of meter, please refer to the manual of smart meter in details.
---	--

This series inverter has integrated export limitation functionality. To use this function, you can connect the Growatt smart meter. For the detailed information, please contact with Growatt.

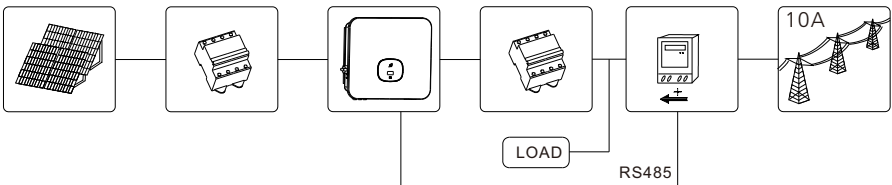

Fig 6.14

Smart meters are classified into the following models		
No.	Meter Brand	Meter Pin NO.
1	Chint	24,RS485A/25,RS485B
2	Eastron	A,RS485A/B,RS485B
3	Growatt	A,RS485A/B,RS485B

Manufacturer	Eastron
Type	SDM630CT-Modbus V3
General Specifications	
Voltage AC (Un)	3*230V
Voltage Range	184~299V AC

Base Current (Ib)	10A
Power consumption	≤2W
Frequency	50/ 60Hz(±10%)
AC voltage withstand	4KV for 1 minute
Impulse voltage withstand	6KV-1.2uS waveform
Overcurrent withstand	20I _{max} for 0.5s
Pulse output 1	1000imp/kWh (default)
Pulse output 2	400imp/kWh
Display Max. Reading	LCD with white backlit 999999kWh
Environment	
Operating temperature	-25°Cto +55°C
Storage and transportation temperature	-40°Cto +70°C
Reference temperature	23°C ±2°C
Relative humidity	0 to 95%, non-condensing
Altitude	up to 2000m
Warm up time	3s
Installation category	CAT II
Mechanical Environment	M1
Electromagnetic environment	E2
Degree of pollution	2
Mechanics	
Din rail dimensions	72x66x100 (WxHxD) DIN 43880
Mounting	DIN rail 35mm
Ingress protection	IP51 (indoor)
Material	self-extinguishing UL94V-0

Active power control with a Radio Ripple Control Receiver(RRCR).

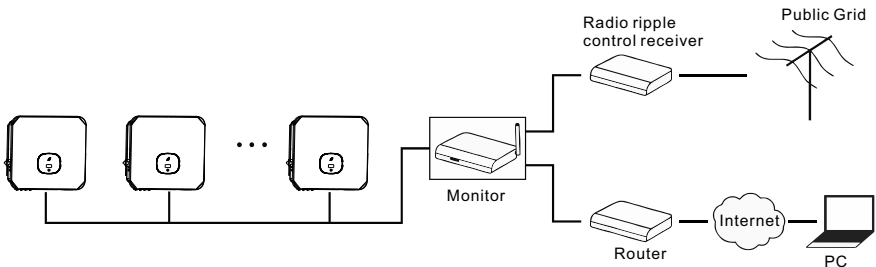





Fig 6.15

6.8 Inverter demand response modes (DRMS)

This series inverter has the function of demand response modes, We use 16-Pin socket as inverter DRMS connection.

 Information	<p>DRMS application description</p> <ul style="list-style-type: none"> ➤ Applicable to AS/NZS4777.2:2015 or Commission Regulation (EU) 2016/631. ➤ DRM0, DRM5, DRM6, DRM7, DRM8 are available.
 CAUTION	<p>Damage to the inverter due to moisture and dust penetration</p> <ul style="list-style-type: none"> ➤ Make sure the cable gland has been tightened firmly. ➤ If the cable gland are not mounted properly, the inverter can be destroyed due to moisture and dust penetration. All the warranty claim will be invalid.
 WARNING	<p>Excessive voltage can damage the inverter! External voltage of DRM PORT don't over +5V.</p>

6.8.1 16-Pin socket pin assignment

No.	Description	Remarks
11	DRM1/5	Relay contact 1 input
12	DRM2/6	Relay contact 2 input
13	DRM3/7	Relay contact 3 input
14	DRM4/8	Relay contact 4 input
15	REF/GEN	GND
16	DRM0/COM	/

6.8.2 Method of asserting demand response modes

Mode	Socket asserted by shorting pins		Function
	Pin 1	Pin 2	
DRM 0	16	15	Operate the disconnection device.
DRM 5	11	15	Do not generate power.
DRM 6	12	15	Do not generate at more than 50% of rated power.
DRM 7	13	15	Do not generate at more than 75% of rated power and reduce the reactive power as far as possible.
DRM 8	14	15	Increase power generation (subject to constraints from other active DRMS).

6.8.3 Using the Power Control Interface for EU

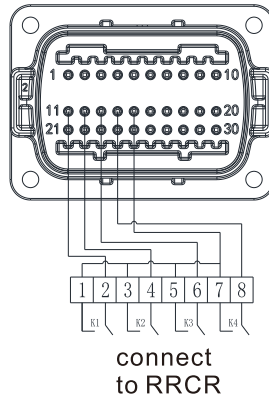

Fig 6.16 Inverter – RRCR Connection

6.8.3.1 The following table describes the connector pin assignment and function:

DRM Socket Pin NO.	Description	Connect to RRCR
11	Relay contact 1 input	K1 – Relay 1 output
12	Relay contact 2 input	K2 – Relay 2 output
13	Relay contact 3 input	K3 – Relay 3 output
14	Relay contact 4 input	K4 – Relay 4 output
15	GND	Relays common node

6.8.3.2 The inverter is preconfigured to the following RRCR power levels:

DRM Socket Pin 11	DRM Socket Pin 12	DRM Socket Pin 13	DRM Socket Pin 14	Active power	Cos(ϕ)
Short circuit with Pin 15				0%	1
	Short circuit with Pin 15			30%	1
		Short circuit with Pin 15		60%	1
			Short circuit with Pin 15	100%	1

Active power control and reactive power control are enabled separately.

6.9 GFCI(Standard)

6.9.1 Ground Fault Circuit Interrupt(GFCI)

This inverter includes an integrated residual current device .If the leakage current is over 300mA and last for more than 300ms,the inverter will report 201 fault and the OLED will display Residual I High.

The inverter has the function of detecting residual current and protecting the inverter against residual current. If your inverter must equip a AC breaker which has the function of detecting residual current ,you must choose a Type A RCD breaker with the rating residual current more than 300mA.

6.10 AFCI(Optional)

6.10.1 Arc-Fault Circuit Interrupter (AFCI)

In accordance with the National Electrical Code R, Article 690.11, the inverter has a system for the recognition of electric arc detection and interruption. An electric arc with a power of 300 W or greater must be interrupted by the AFCI within the time specified by UL 1699B. A tripped AFCI can only be reset manually. You can deactivate the automatic arc fault detection and interruption (AFCI) via a communication product in "Installer" mode if you do not require the function. The 2011 edition of the National Electrical Code R, Section 690.11 stipulates that newly installed PV systems attached to a building must be fitted with a means of detecting and disconnecting serial electric arcs (AFCI) on the PV side.

6.10.2 Danger information



Danger of fire from electric arc
Only test the AFCI for false tripping in the order described below.
Do not deactivate the AFCI permanently.

If an "Error 200" message is displayed, the buzzer alarms, an electric arc occurred in the PV system. The AFCI has tripped and the inverter is in permanent shutdown. The inverter has large electrical potential differences between its conductors. Arc flashes can occur through air when high-voltage current flows. Do not work on the product during operation.

When the inverter error 200, please follow the steps:

6.10.3 Operation step

6.10.3.1 Turn the DC & AC Switch to position "OFF".

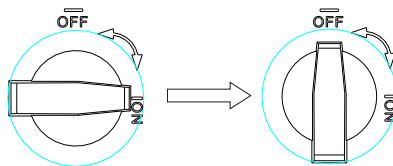

Fig 6.17

Wait for the screen be off.

6.10.3.2 Perform troubleshooting on the PV system:

Check the PV strings' open circuit voltage is normal or not.

6.10.3.3 After the fault is rectified, restart the inverter:

Turn the DC & AC Switch to position "ON" .

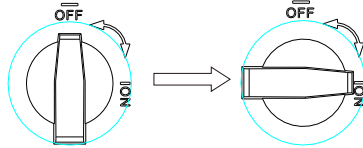

Fig 6.18

6.11 Backup(optional)

Backup means that the inverter can output 230/400V, 50/60Hz voltage to the load when there is no grid. The MOD-XH inverter has the Backup function. If you need to use this function, you need an additional Backup box. The system diagram is as the figure below.

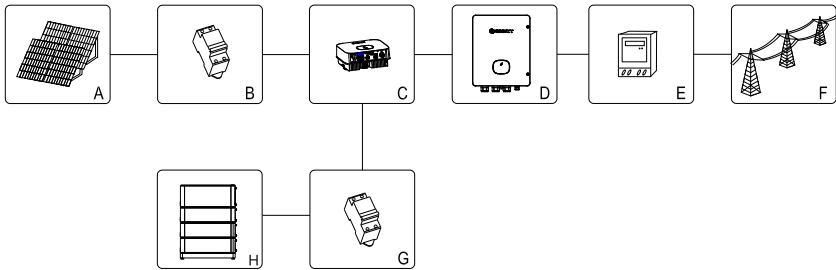

Fig 6.19

Connection communication cable to the XH inverter

COM Port	XH Inverter COM	SYN 50-XH 30 COM	Control Board
RS 485 A	PIN17	PIN3	CN8
RS 485 B	PIN18	PIN4	
BOX.EN+	PIN21	PIN5	
BOX.EN-	PIN22	PIN6	

As shown in Fig 6.19 above, a complete PV storage system includes PV panels, inverters, backup box, public grid and other accessories. In this system, the photovoltaic inverter is a key device. If the customer want to enable the Backup mode, please refer to 9.3.3 Backup Mode Setting.

Note:

- 1.The max. power output at the off grid is 10kW when the battery power is enough.
- 2.The backup function is permitted to be commissioned only by professionals. The backup function requires a backup box provided by Growatt.

7 Debugging

1. Turn on the DC switch on the inverter. As long as the input DC voltage is greater than 140V, the inverter display will show the following information: No AC connection error, the inverter LED will turn red.

If other information is displayed, please refer to Chapter 13. If you encounter any problems during the debugging process and cannot solve it, please contact customer service.

2. Close the circuit breaker or switch between the inverter and the grid, the inverter will start a countdown to the self-check, and after the self-check is normal, it will be connected to the grid.

3. In normal operation, the leaves of the inverter indicator window will turn green.

4. Finish debugging.

8 Working Mode

8.1 Normal mode

In this mode, the inverter works normally.

- When the DC voltage is greater than 160V, the energy is sufficient, and the grid voltage frequency meets the grid-connected requirements, the inverter will convert the energy of the solar panels into AC power and export to the grid, and the green LED will light up.
- When the DC voltage is lower than 140V, the inverter will automatically disconnect from the grid and exit the normal operation mode. When the input voltage reaches the requirement again and the grid voltage and frequency return to normal, the inverter will automatically connect to the grid.

8.2 Failure mode

The inverter controls the chip monitors and adjusts the state of the system in real time. When the inverter monitors any unexpected conditions, such as system failure and inverter failure, the display will show the fault information. In the failure mode, the inverter will indicate the leaves of the window will turn red and the inverter output will be disconnected from the grid.

8.3 Shutdown mode

When the sunlight is weak or there is no sunlight, the inverter will automatically stop running. When in shutdown mode, the inverter basically does not consume energy from the grid or solar panels, and at the same time, the inverter's display screen and LED lights will be turned off.

OLED display and touch button 9

The OLED display can display the running status of the inverter, as well as various parameters information, and the display interface of the inverter can be switched and the inverter parameters can be set by touching the button.

9.1 Start the inverter

9.1.1 Touch control

Mark	Describe	Explain	
	Touch mark	Single touch	Switch the display interface or the current number plus 1
		Double touch	Enter the setting state or confirm
		Triple touch	Return to the previous display interface
		Long press for 5s	The current data returns to the default value

9.1.2 Set Country/Area

 Information	Country setting ➤Before starts up the inverter,we need to select the right Country/Area,if we don't select any Country/Area, the inverter will run under AS/NZS4777.2 as default for Australia,or run under VDE0126-1-1 for other region after 30s.
---	---

When inverter powered on, OLED will light automatically. Once the PV power is sufficient, OLED displays “PV Inverter”, Press the touch key once a second to scroll through the different Country, showing on the screen will constantly change. For example, if you want to choose Germany, press the touch key until the OLED display shows “VDE0126”, Long press the touch key for 5 seconds, the OLED shows Country/Area setting is complete.

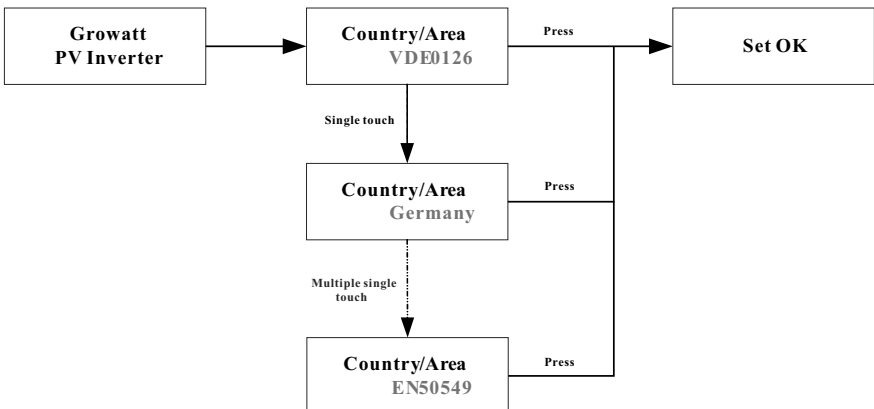

9.2 General setting

9.2.1 Set inverter display language

This series inverter provides multi languages. Single touch to select different language. Double touch to confirm the setting. Set the language as described below:

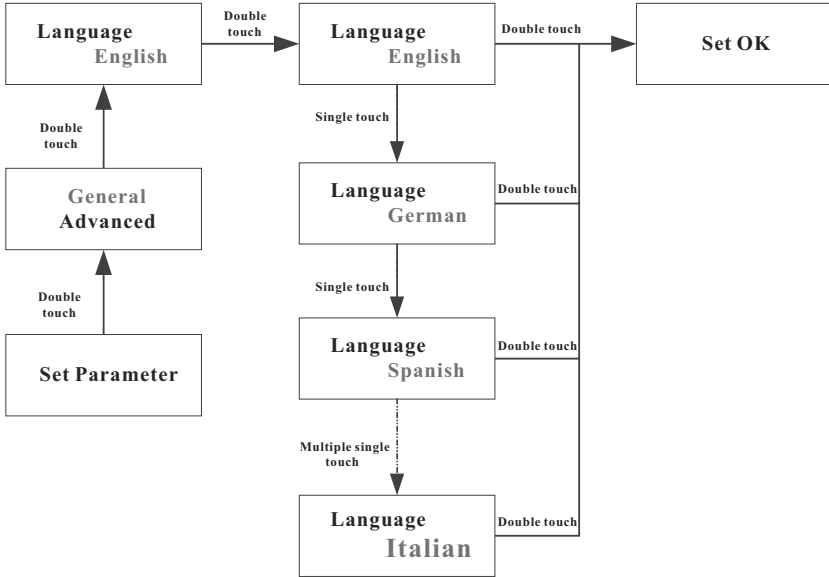

9.2.3 Set inverter date

Single touch make the number up. Double touch to confirm the setting. Set inverter date as described below:

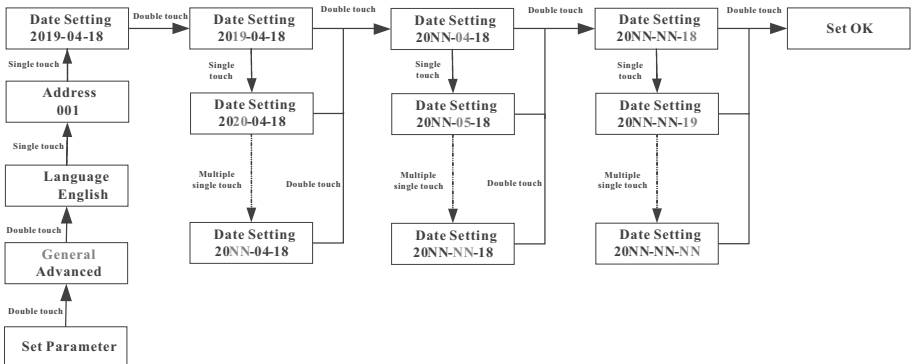

9.2.4 Set inverter time

Single touch make the number up.Double touch to confirm the setting.
Set inverter time as described below:

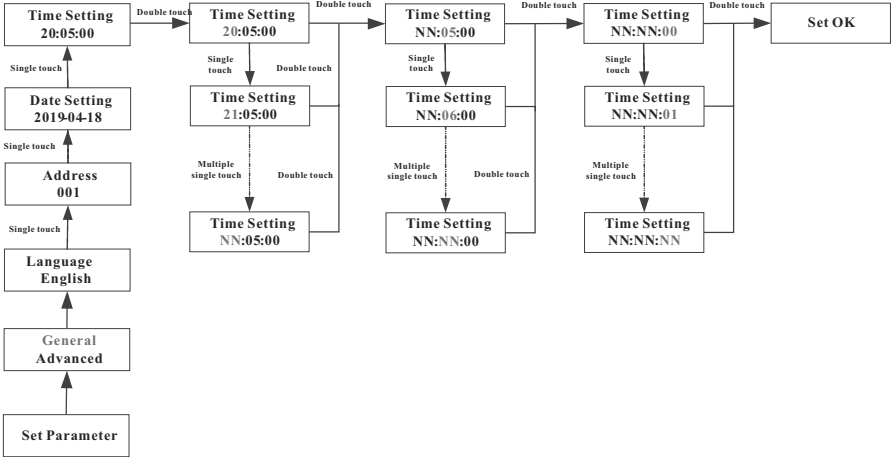

9.3 Advanced setting

Single touch to switch display or make the number +1.Double touch to confirm the setting.The password of advanced setting is 123.Input right password,you can change Country/Area,Region and PQRM settings.

Reset Country

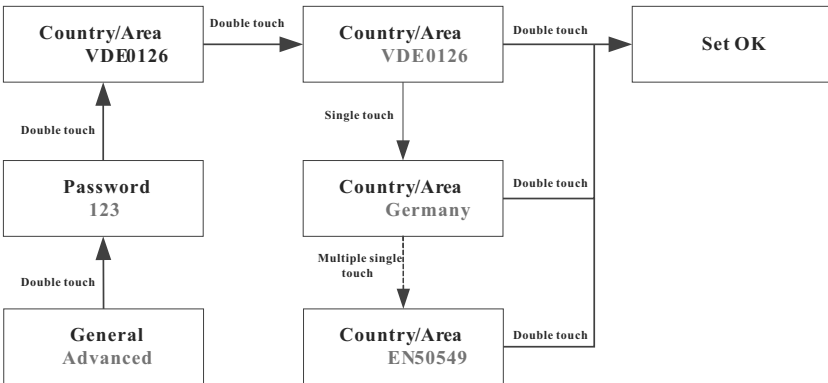

9.3.1 Export limitation setting

The -XH series inverters can work in anti-backflow mode through external power meter or CT, the user can set the percentage of power allowed to flow backward through

the OLED, Single touch to switch display or make the number +1. Double touch to confirm the setting, as described below:

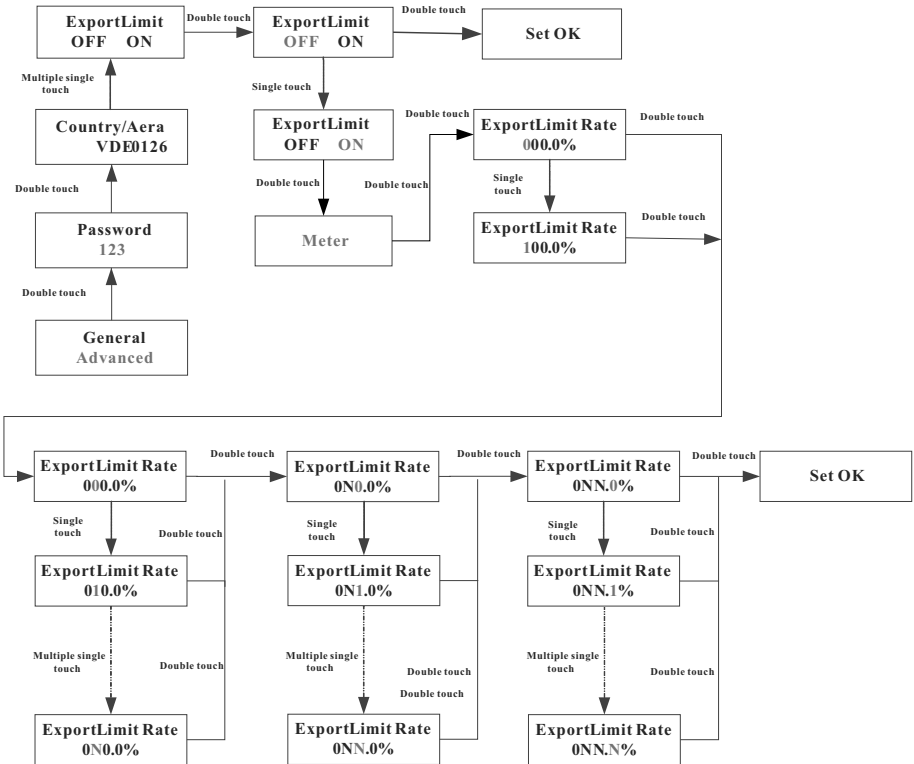

9.3.2 Reset factory

 Information	<p>Perform this operation with caution because all configured parameters except the current date,time, and model parameters will be restored to their factory defaults.</p>
---	---

Single touch to switch display or make the number +1. Double touch to confirm the setting.

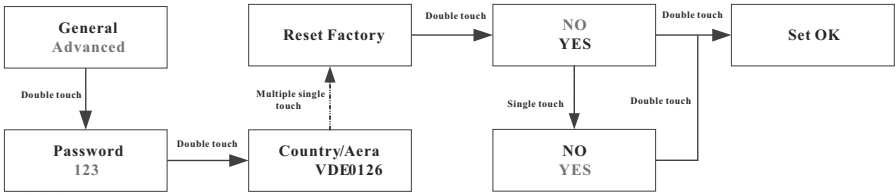

9.3.3 Backup mode setting (Off-grid models only)

When the –XH series inverter is used with the Battery and the Backup box, the Grid is abnormal, the inverter can work in backup mode to provide energy to the off-grid load. The maximum output power same as inverter rated power. In the Backup mode you can set the output voltage (default is 230V/400V) and output frequency (default is 50Hz). If the Backup mode is disabled (the inverter will turn off the output when the grid is absent). The user can enable the Backup mode through OLED settings. Single touch to switch display or make the number +1. Double touch to confirm the setting, as described below:

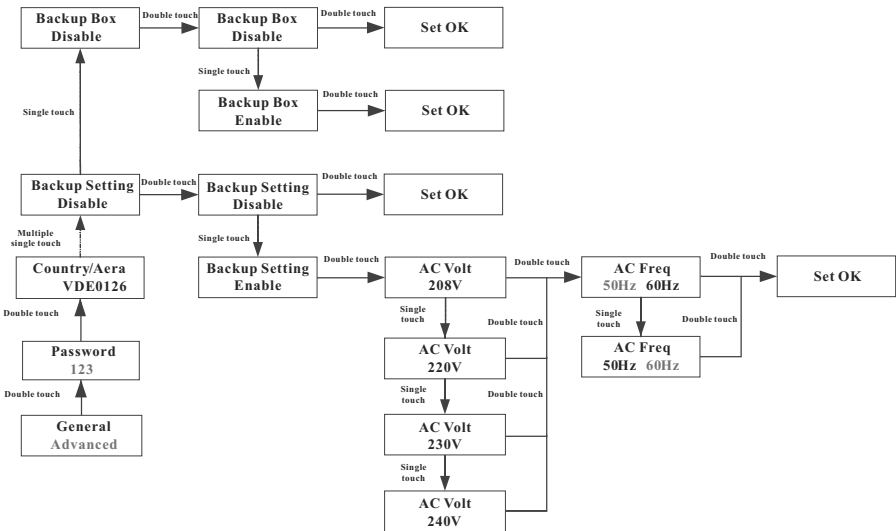

9.3.4 Grid Charge setting

When the –XH series inverter is used together with the battery, the inverter can absorb the energy from the grid to charge the battery, and the user can enable the grid charging function (default is disable) through the OLED. Single touch to switch display or make the number +1. Double touch to confirm the setting. as described below:

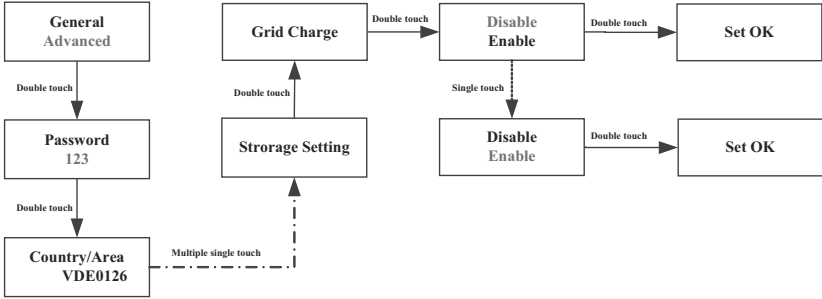

9.3.5 Power derating for voltage variation (Volt-Watt mode)

The inverter power output will vary in response to the AC grid voltage. This is switched on by default. This function belongs to advanced function, if you need to change, please contact the after-sales operation and maintenance to make adjustments.

9.3.6 Reactive power regulation for voltage variation (Volt-VAr mode)

The power output or input will vary in response to the AC grid voltage. This function is switched off by default. This function belongs to advanced function, if you need to change, please contact the after-sales operation and maintenance to make adjustments.

Communication and Monitoring 10

10.1 COM port

This series of inverters provide four RS485 ports. You can monitor one or more inverters via RS485. The other RS485 port is used to connect a smart meter (Export limitation and self-consumption monitoring).

No.	Description	Function
1	+12V	Dry contact: the power of any external wiring connected to it should not be greater than 2W
2	COM	
3	RS485A1	RS485 communication port
4	RS485B1	
5	RS485A3	Meter communication port
6	RS485B3	
7	RS485A2	Battery communication port
8	RS485B2	
9	BAT.EN+	Battery wake-up signal
10	BAT.EN-	
11	DRM1/5	Relay contact 1 input
12	DRM2/6	Relay contact 2 input
13	DRM3/7	Relay contact 3 input
14	DRM4/8	Relay contact 4 input
15	REF/GEN	GND
16	DRM0/COM	/
17	RS485A4	Backup box communication
18	RS485A5	
21	BOX.EN+	Backup box identification signal
22	BOX.EN-	

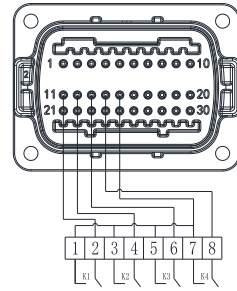

Fig 10.1

No.	RRCR Description	Active Power
11	K1-out	0%
12	K2-out	30%
13	K3-out	60%
14	K4-out	100%
15	Relays common node	/
16	/	/

10.2 USB-A

USB-A port is mainly used to connect monitoring module or firmware update : We can connect the external optional monitoring modules, such as Shine WIFI-X, Shine Shine 4G-X, Shine LAN-X, etc. to the USB interface for monitoring.

Steps for installing the monitoring module: Make sure ▲ is on the front side, then insert the datalogger and tighten the screws.

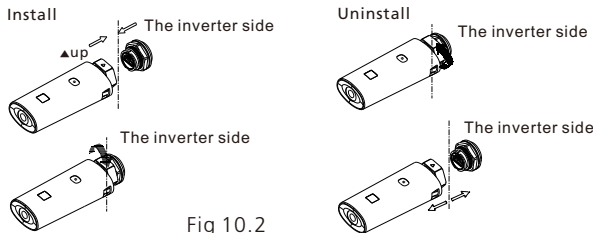

Fig 10.2

11 Maintenance and Cleaning

11.1 Checking Heat Dissipation

If the inverter regularly reduces its output power due to high temperature, please improve the heat dissipation condition. Maybe you need to clean the heat sink.

11.2 Cleaning the Inverter

If the inverter is dirty, turn-off the AC breaker and DC switch ,waiting the inverter shut down ,then clean the enclosure lid, the display, and the LEDs using only a wet cloth. Do not use any cleaning agents (e.g. solvents or abrasives).

11.3 Checking the DC Disconnect

Check for externally visible damage and discoloration of the DC Disconnect and the cables at regular intervals.If there is any visible damage to the DC Disconnect, or visible discoloration or damage to the cables, contact the installer.

- Once a year, turn the rotary switch of the DC Disconnect from the On position to the Off position 5 times in succession. This cleans the contacts of the rotary switch and prolongs the electrical endurance of the DC Disconnect.

12 Start and shut down the inverter

12.1 Start the inverter

Before turning the inverter on, please make sure the PV/Battery input voltage and current are within the MPPT limits.

Follow the steps below to turn the inverter on:

- 1.Pull the PV/Battery and AC cable make sure there is no loose or shaking.
- 2.Make sure the cable polarity is correct and voltage is less than 1100V
- 3.Switch on the build-in DC isolator at the bottom of the inverter.
- 4.Switch on the PV/Battery Array and DC isolator next to your inverter, if you can not find this switch, skip this step.
- 5.Switch on the Solar AC isolator if the inverter is more than 3 meters away from your switchboard.
- 6.Switch on the solar supply main switch in the switch board.

12.2 Shut down the inverter



DANGER

Don't disconnect the DC connector while the inverter is connected to the grid.

Steps to turn off the inverter:

1. Disconnect the AC circuit breaker to prevent the inverter from starting again;
2. Turn off the DC switch;
3. Turn off the BAT input switch of the BAT;
4. Check the operating status of the inverter;
5. Wait until the LED and OLED display are off, indicating that the inverter is turned off.

Troubleshooting 13

13.1 Error message

When a malfunction occurs, an error message will be displayed on the OLED screen and the LED indicator red will light up. Faults include system faults and inverter faults. In some cases, you may be advised to contact Growatt, please provide the following information.

Information about the inverter:

- Serial number
- Model
- Error message on OLED
- A short description of the problem
- Grid voltage
- DC input voltage
- Can you reproduce the failure? If so, how?
- Has this problem occurred in the past?
- What were the environmental conditions when the problem occurred?

Information about photovoltaic panels:

- PV panel manufacturer's name and model
- Panel output power
- Voc of the panel
- Vmp of the panel
- Imp of the panel
- The number of panels in each string
- If you need to replace the device, please ship it to the original box.

13.2 System error

Warning Code

Warning message	Description	Suggest
Warning 200	String fault	1.After shutdown,Check the panel is normal. 2.If error message still exists, contact manufacturer.
Warning 201	String PID quick connect terminal detection error	1. After shutdown,Check the string terminal wiring. 2.If the error message still exists, contact the manufacturer.
Warning 202	DC SPD function abnormal	1.After shutdown,Check the DC SPD. 2.If error message still exists,contact manufacturer.
Warning 203	PV Circuit short	1.Check the PV1 or PV2 wiring is short-circuited. 2.If error message still exists,contact manufacturer.
Warning 204	Dry contact function abnormal	1.After shutdown,Check the dry Dry contact wiring. 2.If the error message still exists, contact manufacturer.
Warning 205	PV Boost driver broken	1.Restart inverter. 2.If error message still exists,contact manufacturer.
Warning 206	AC SPD function abnormal	1.After shutdown,Check the AC SPD. 2.If error message still exists,contact manufacturer.

Warning message	Description	Suggest
Warning 207	U disk over-current protection	1.Unplug the U disk. 2.Re-access U disk after shutdown. 3.If the error message still exists, contact manufacturer.
Warning 208	DC Fuse Open	1.After shutdown,Check fuse. 2.If error message still exists, contact manufacturer.
Warning 209	The DC input voltage is exceeding the maximum tolerable value.	1.Immediately disconnect the DC switch and check the voltage. 2.If the fault code still exists after the normal voltage is restored, contact manufacturer.
Warning 210	PV Reversed	1.Check PV input terminals. 2.If error message still exists,contact manufacturer.
Warning 300	No Utility	1.Please confirm grid is lost or not. 2.If error message still exists,contact manufacturer.
Warning 301	Grid voltage outrange	1.Check the AC voltage is in the range of standard voltage in specification. 2.If error message still exists,contact manufacturer.
Warning 302	Grid frequency outrange	1.Check the frequency is in the range of specification or not. 2.If error message still exists,contact manufacturer.
Warning 303	EPS mode, over load	1.Please reduce the load of EPS output. 2.If error message still exists,contact manufacturer.
Warning 304	CT Open or Wrong	1.Check if AC current sensor is connected well. 2.If error message still exists,contact manufacturer.
Warning 305	CT line reversed or Ground fail	1.Check the L line and N line of SP-CT is reversed or not. 2.If error message still exists,contact manufacturer.
Warning 306	Communication fault,M3 didn't receive SP-CT data	1.Check communication wire. 2.If error message still exists,contact manufacturer.
Warning 307	Communication fault	1.Check communication wire. 2.If error message still exists,contact manufacturer.
Warning 400	Fan function abnormal	1. After shutdown,Check the fan connection. 2.replace the fan. 3.If the error message still exists, contact manufacturer.

Warning message	Description	Suggest
Warning 401	Meter abnormal	1. Check if the meter is on. 2. Check the machine and the meter connection is normal.
Warning 402	Optimizer and inverter communication is abnormal	1. Check if the optimizer is on. 2. Check whether the connection between the optimizer and the inverter is normal.
Warning 403	String communication abnormal	1. After shutdown, Check the string panel wiring. 2. If the error message still exists, contact manufacturer .
Warning 404	EEPROM abnormal.	1. Restart inverter. 2. If error message still exists, contact manufacturer.
Warning 405	DSP and COM firmware version unmatched	1. Check the firmware version. 2. If error message still exists, contact manufacturer.
Warning 406	Boost module error	1. Restart inverter. 2. If error message still exists, contact manufacturer.
Warning 500	SPH failed to communication with lithium battery	1. Check the lithium Battery is open or not. 2. Check the connection of lithium Battery and inverter is good or not.
Warning 501	Battery terminal open (only for lithium battery)	1. Check the battery is connected. 2. If error message still exists, contact manufacturer.
Warning 502	Battery Voltage high	1. Check the voltage of battery is in the range of specification or not. 2. Check the battery connection is right or not. 3. If error message still exists, contact manufacturer.
Warning 503	Battery Voltage Low	1. Check the voltage of battery is in the range of specification or not. 2. Check the battery connection is right or not. 3. If error message still exists, contact manufacturer.
Warning 504	Battery terminals reversed	1. Check the positive and negative of battery is reversed or not. 2. If error message still exists, contact manufacturer.
Warning 505	Lead-acid battery temperature sensor was open	1. Check the temperature of lead-acid battery is installed or not. 2. Check the temperature of lead-acid battery is connected well or not. 3. If error message still exists, contact manufacturer.

Warning message	Description	Suggest
Warning 506	Battery temperature outrange	1.Check the environment temperature of battery is in the range of specification or not. 2.If error message still exists,contact manufacturer.
Warning 507	BMS failure and neither charge and discharge is allowe	1.Depend on BMS error code. 2.If error message still exists,contact manufacturer.
Warning 508	Lithium battery Over Load Fault	1.Check whether output load over Lithium battery rate power; If load too large, please reduce load. 2.If error message still exists, contact manufacturer.
Warning 509	BMS Battery Msg Failure	1.Restart inverter. 2.If error message still exists, contact manufacture.
Warning 510	BAT SPD function abnormal	1.After shutdown,Check the BAT SPD. 2.If error message still exists,contact manufacturer.
Warning 600	DCI bias abnormal	1.Restart inverter. 2.If error message still exists,contact manufacturer.
Warning 601	DC Voltage High Fault	1.Restart inverter. 2.If error message still exists,contact manufacturer.
Warning 602	Off-grid output voltage is too low	1.Restart inverter. 2.If error message still exists, contact manufacturer.
Warning 603	The off-grid output voltage is too high	1.Restart inverter. 2.If error message still exists, contact manufacturer.
Warning 604	The off-grid output current is overcurrent	1. Check whether the load exceeds the inverter specification. 2.Restart inverter,If error message still exists,contact manufacturer.
Warning 605	The off-grid Bus voltage is too low	1. Check whether the load exceeds the inverter specification. 2. Restart inverter,If error message still exists,contact manufacturer.
Warning 606	The off-grid output is overloaded	1. Check whether the load exceeds the inverter specification. 2. Restart inverter,If error message still exists,contact manufacturer.
Warning 607	Abnormal communication alarm with off-grid box	1. Check and off-grid box communication wiring after shutdown. 2. If error message still exists,contact manufacturer.

Warning message	Description	Suggest
Warning 608	Off-grid box abnormal alarm	1.Restart inverter. 2.If error message still exists,contact manufacturer.
Warning 700	The off-grid box fan is faulty	1.Check the fan wiring after powering it down. 2.If error message still exists,contact manufacturer.
Warning 701	The generator started abnormally	1.Check the generator and wiring after shutdown. 2.If error message still exists,contact manufacturer.

13.3 System error

Error code	Description	Suggest
Error 200	AFCI Fault	1.After shutdown,Check the panel terminal. 2.Restart inverter. 3.If error message still exists,contact manufacturer.
Error 201	Leakage current too high.	1.Restart inverter. 2.If error message still exists,contact manufacturer.
Error 202	The DC input voltage is exceeding the maximum tolerable value.	1.Immediately disconnect the DC switch and check the voltage. 2.If the fault code still exists after the normal voltage is restored, contact manufacturer.
Error 203	PV isolation Low	1.After shutdown, check whether the panel shell is reliably grounded. 2.If error message still exists,contact manufacturer.
Error 300	AC V Outrange	1.Check grid voltage. 2.If the error message still exists despite the grid voltage being within the tolerable range, contact manufacturer.
Error 301	AC terminals reversed	1.Check AC terminals. 2.If error message still exists,contact manufacturer.
Error 302	No AC Connection	1.After shutdown,Check AC wiring. 2.If error message still exists,contact manufacturer.
Error 303	NE abnormal	1.Check PE,to ensure that the PE line contact good. 2.If error message still exists,contact Manufacturer.
Error 304	AC F Outrange	1.Restart inverter. 2.If error message still exists,contact manufacturer.
Error 305	Over Load Fault	1.Check whether output load over range; If load too large, please reduce load. 2.If error message still exists, contact manufacturer.

Error code	Description	Suggest
Error 306	CT LN Reversed	1.After shutdown, Check the SP-CT connection. 2.If error message still exists,contact manufacturer.
Error 307	Communication fault,M3 didn't receive SP-CT data	1.Check communication wire. 2.If error message still exists,contact manufacturer.
Error 308	Communication fault;Pairing time too long	1.Restart pairing. 2.If error message still exists,contact manufacturer.
Error 400	DCI bias abnormal	1.Restart inverter. 2.If error message still exists, contact manufacturer.
Error 401	DCVoltage High Fault	1.Restart inverter. 2.If error message still exists,contact manufacturer.
Error 402	Output DC current too high.	1.Restart inverter. 2.If error message still exists,contact manufacturer.
Error 403	Output current unbalance	1.After shutdown,Check the output current is not balanced. 2.If the error message still exists, contact manufacturer.
Error 404	bus sample fault	1.Restart inverter. 2.If error message still exists,contact manufacturer.
Error 405	Relay fault	1.Restart inverter. 2.If error message still exists,contact manufacturer.
Error 406	Init model fault	1.Reset mode. 2.If error message still exists,contact manufacturer.
Error 407	AutoTest failure	1.Restart inverter. 2.If error message still exists,contact manufacturer.
Error 408	NTC Temperature too high	1.After shutdown,Check the temperature, normal restart the inverter. 2.If the error message still exists, contact manufacturer.
Error 409	Bus voltage abnormal	1.Restart inverter. 2.If error message still exists,contact manufacturer.
Error 410	Communication board and control panel sampling battery voltage is inconsistent	1.Restart inverter. 2.If error message still exists, contact manufacturer.
Error 411	Communication fault	1.After shutdown,Check communication board wiring. 2.If the error message still exists, contact manufacturer.
Error 412	Temperature sensor connection is abnormal	1.After shutdown,Check the temperature sampling module is connected properly. 2.If the error message still exists, contact manufacturer.

Error code	Description	Suggest
Error 413	IGBT drive fault	1.Restart inverter. 2.If error message still exists,contact manufacturer.
Error 414	EEPROM fault	1.Restart inverter. 2.If error message still exists, contact manufacturer.
Error 415	Internal power test fail(PV Power low)	1.Restart inverter. 2.If error message still exists,contact manufacturer.
Error 416	Over current protected by software	1.Restart inverter. 2.If error message still exists,contact manufacturer.
Error 417	The grid voltage sampling is inconsistent	1.Restart the machine; 2.If the fault information still exists,contact the manufacturer.
Error 418	DSP and COM firmware version unmatch	1.Check the firmware version. 2.If error message still exists,contact manufacturer.
Error 419	Inconsistent leakage current sampling	1.Restart the machine. 2.If the fault information still exists,contact the manufacturer.
Error 420	GFCI Module damage	1.After shutdown,Check the leakage current module. 2.If the error message still exists, contact manufacturer
Error 421	CPLD is abnormal	1.Restart inverter. 2.If error message still exists,contact manufacturer.
Error 422	sampling is inconsistent	1.Restart inverter. 2.If error message still exists,contact manufacturer.
Error 425	AFCI self-test fault	1.Restart inverter. 2.If error message still exists, contact manufacturer.
Error 500	BMS Communication fault	1.Check 485 cable between SP and battery . 2.Check if battery is sleeping. 3.If error message still exists,contact manufacturer.
Error 501	BMS failure and neither charge and discharge is allowe	1.Depend on BMS error code. 2.If error message still exists,contact manufacturer.
Error 502	Battery voltage low	1.Check battery voltage. 2.If error message still exists,contact manufacturer.
Error 503	Battery Voltage High	1.Check whether the battery vlttage too high; if battery OK, please restart the inverter; if not, please replace battery. 2.If error message still exists,contact manufacturer.

Error code	Description	Suggest
Error 505	Battery terminals reversed	1. Check battery terminals. 2. If error message still exists, contact manufacturer.
Error 506	Battery terminal open (only for lithium battery)	1. Check battery terminal. 2. If error message still exists, contact manufacturer.
Error 507	Lithium battery Over Load Fault	1. Check whether output load over Lithium battery rate power; If load too large, please reduce load. 2. If error message still exists, contact manufacturer.
Error 508	BUS2 Volt Abnomal	1. Restart inverter. 2. If error message still exists, contact manufacturer.
Error 509	Bat Charge Ocp	1. Check whether the PV voltage is overconfigured. 2. If error message still exists, contact manufacturer.
Error 510	Bat DisCharge Ocp	1. Check whether the battery discharge current is properly set. 2. If error message still exists, contact manufacturer.
Error 511	BatSoftStartFault	1. Restart inverter. 2. If error message still exists, contact manufacturer.
Error 600	EPS OP Short Fault	1. Restart inverter. 2. If error message still exists, contact manufacturer.
Error 601	Bus low	1. Check whether the battery works properly. 2. If error message still exists, contact manufacturer.
Error 602	AC port volt Abnormal	1. Check whether the AC port has voltage. 2. If error message still exists, contact manufacturer.
Error 603	Soft start run out of time	1. Restart inverter. 2. If error message still exists, contact manufacturer.
Error 604	Off-grid output voltage is too low	1. Restart inverter. 2. If error message still exists, contact manufacturer.
Error 605	Balance Circuit fault	1. Restart inverter. 2. If error message still exists, contact manufacturer.
Error 606	DC Voltage High Fault	1. Restart inverter. 2. If error message still exists, contact manufacturer.
Error 607	EPS output over load	1. Restart inverter. 2. If error message still exists, contact manufacturer.
Error 608	OfflineSignError	1. Check offline parallel signal. 2. If error message still exists, contact manufacturer.
Error 609	The off-grid box is not detected	1. Check the off-grid box after shutdown to identify the signal wiring. 2. If error message still exists, contact manufacturer.
Error 700	Abnormal communication with the inverter	1. Check and communicate with the inverter after shutdown. 2. If error message still exists, contact manufacturer.

Error code	Description	Suggest
Error 701	Off-grid box grid-side relay failure	1.Restart the off-grid box. 2.If error message still exists,contact manufacturer.
Error 702	Off-grid box generator access relay fault	1.Restart the off-grid box. 2.If error message still exists,contact manufacturer.
Error 703	Off-grid boxes are overloaded	1.Restart the off-grid box. 2.If error message still exists,contact manufacturer.
Error 704	Off-grid boxes are overloaded off-grid split-phase	1.Reduce the load. 2.If error message still exists,contact manufacturer.
Error 705	Overheat inside the off-grid box	1.Restart the off-grid box. 2.If error message still exists,contact manufacturer.

14 Manufacturer warranty

Please refer to the warranty card.

15 Decommissioning

15.1 Dismantling the Inverter

1. Disconnect the inverter as described in section 8.
2. Remove all connection cables from the inverter.



CAUTION

Danger of burn injuries due to hot enclosure parts!

Wait 20 minutes before disassembling until the housing has cooled down.

3. Screw off all projecting cable glands.
4. Lift the inverter off the bracket and unscrew the bracket screws.

15.2 Packing the Inverter

If possible, always pack the inverter in its original carton and secure it with tension belts. If it is no longer available, you can also use an equivalent carton. The box must be capable of being closed completely and made to support both the weight and the size of the inverter.

15.3 Storing the Inverter

Store the inverter in a dry place where ambient temperatures are always between -25°C and $+60^{\circ}\text{C}$.

15.4 Disposing of the Inverter



Do not dispose of faulty inverters or accessories together with household waste. Please accordance with the disposal regulations for electronic waste which apply at the installation site at that time. Ensure that the old unit and, where applicable, any accessories are disposed of in a proper manner

EU Declaration of conformity 16

With the scope of EU directives:

- 2014/35/EU Low Voltage Directive (LVD)
- 2014/30/EU Electromagnetic Compatibility Directive (EMC)
- 2011/65/EU RoHS Directive and its amendment (EU)2015/863

Shenzhen Growatt New Energy Co. Ltd confirms that the Growatt inverters and accessories described in this document are in compliance with the above mentioned

EU directives. The entire EU Declaration of Conformity can be found at www.ginverter.com

17 Specification

17.1 Parameter

Specifications \ Model	MOD 3000TL3-XH	MOD 4000TL3-XH	MOD 5000TL3-XH	MOD 6000TL3-XH
Input data(DC)				
Max. recommended PV power(for module STC)	6000W	8000W	10000W	12000W
Max. DC voltage	1100V			
Start voltage	160V			
Nominal voltage	600V			
MPP voltage range	140-1000V			
No. of MPP trackers	2			
No. of PV strings per MPP trackers	1/1	1/1	1/1	1/1
Max. input current per MPP trackers	16A/16A	16A/16A	16A/16A	16A/16A
Max. short-circuit current per MPP trackers	20/20A			
Backfeed current to PV array	0A			
DC Battery				
Compatible battery	ARK-XH HV Battery (7.68kWh~25.6kWh)			
Operating voltage range	600 V ~ 950 V			
Max.operating current	11A			
Max.discharge power	3300W	4400W	5500W	6600W
Max.charge power	6000W			
Output data(On-gird)				
AC nominal power	3000W	4000W	5000W	6000W
Max. AC apparent	3300VA	4400VA	5500VA	6600VA
Nominal AC voltage/range	230/400V			
AC grid frequency/range	50/60 Hz 45~55Hz/55-65 Hz			
Max. output current	5.0A	6.7A	8.3A	10.0A
AC inrush current	30A			
Max. output fault current	26.7A			
Max. output overcurrent Protection	26.7A			
Power factor(@nominal power)	>0.99			

Model Specifications	MOD 3000TL3-XH	MOD 4000TL3-XH	MOD 5000TL3-XH	MOD 6000TL3-XH
THDi	<3%			
AC grid connection type	3W+N+PE			
Efficiency				
Max. efficiency	98.30%			
Euro-eta	97.50%			
Output data(Backup)				
Nominal output power	3kW	4kW	5kW	6kW
Max. apparent power	3kVA	4kVA	5kVA	6kVA
Nominal AC output voltage	230V/400V			
Nominal AC output frequency	50Hz			
Max. output current	4.4A	5.8A	7.3A	8.7A
Power factor	0.8 leading to 0.8 lagging			
THDv	THDv \leq 2%@Rload, THDv \leq 5%@RCDload			
DCV	\leq 300mV AVG.			
Switch time	<500ms			
Protection devices				
DC reverse-polarity protection	YES			
DC switch	YES			
DC Surge protection	YES			
Insulation resistance monitoring	YES			
AC surge protection	YES			
AC short-circuit protection	YES			
Grid monitoring	YES			
Anti-islanding protection	YES			
Residual-current monitoring unit	YES			
String Fuse protection	NO			
String monitoring	YES			
AFCl protection	YES			

Model	MOD 3000TL3-XH	MOD 4000TL3-XH	MOD 5000TL3-XH	MOD 6000TL3-XH
Specifications				
General data				
Dimensions (W / H / D) in mm	425*387*147mm			
Weight	13kg			
Operating temperature range	-25°C ... +60°C (>45°C Derating)			
Noise emission (typical)	≤29dB(A)			
Altitude	3000m			
Internal consumption at night	<5.5W			
Topology	Transformerless			
Cooling	Natural heat dissipation			
Electronics protection degree	IP66			
Relative humidity	0~100%			
DC connection	H4/MC4(OPT)			
AC connection	quick connect terminal			
Interfaces				
Display	OLED+LED			
USB/RS485	YES			
WIFI/GPRS/4G/RF/LAN	OPT			

Model	MOD	MOD	MOD	MOD	MOD
Specifications	7000TL3-XH	8000TL3-XH	9000TL3-XH	10KTL3-XH	10KTL3-XH BE
Input data(DC)					
Max. recommended PV power(for module STC)	14000W	16000W	18000W	20000W	20000W
Max. DC voltage	1100V				
Start voltage	160V				
Nominal voltage	600V				
MPP voltage range	140-1000V				
No. of MPP trackers	2				
No. of PV strings per MPP trackers	1/1	1/1	1/1	1/1	1/1
Max. input current per MPP trackers	16A/16A	16A/16A	16A/16A	16A/16A	16A/16A
Max. short-circuit current per MPP trackers	20/20A				
Backfeed current to PV array	0A				
DC Battery					
Compatible battery	ARK-XH HV Battery (7.68kWh~25.6kWh)				
Operating voltage range	600 V ~ 950 V				
Max.operating current	18.5A				
Max.discharge power	7700W	8800W	9900W	10/11kW	10kW
Max.charge power	10kW				
Output data(on-grid)					
AC nominal power	7000W	8000W	9000W	10kW	10kW
Max. AC apparent	7700VA	8800VA	9900VA	10/11KVA	10KVA
Nominal AC voltage/range	230/400V				
AC grid frequency/range	50/60 Hz 45~55Hz/55-65 Hz				
Max. output current	11.7A	13.3A	15.0A	16.7A	15.2A
AC inrush current	30A				
Max. output fault current	42.7A				
Max.output overcurrent Protection	42.7A				

Model	MOD	MOD	MOD	MOD	MOD
Specifications	7000TL3-XH	8000TL3-XH	9000TL3-XH	10KTL3-XH	10KTL3-XH BE
Power factor (@nominal power)	>0.99				
THDi	<3%				
AC grid connection type	3W+N+PE				
Efficiency					
Max. efficiency	98.60%				
Euro-eta	98.10%				
Output data(Backup)					
Nominal output power	7kW	8kW	9kW	10kW	10kW
Max. apparent power	7kVA	8kVA	9kVA	10kVA	10kVA
Nominal AC output voltage	230V/400V				
Nominal AC output frequency	50Hz				
Max. output current	10.2A	11.6A	13.1A	14.5A	14.5A
Power factor	0.8 leading to 0.8 lagging				
THDv	THDv \leq 2%@Rload, THDv \leq 5%@RCDload				
DCV	\leq 300mV AVG.				
Switch time	<500ms				
Protection devices	YES				
DC reverse-polarity protection	YES				
DC switch	YES				
DC Surge protection	YES				
Insulation resistance monitoring	YES				
AC surge protection	YES				
AC short-circuit protection	YES				
Grid monitoring	YES				
Anti-islanding protection	YES				
Residual-current monitoring unit	YES				
String Fuse protection	NO				
String monitoring	YES				

Model	MOD	MOD	MOD	MOD	MOD
Specifications	7000TL3-XH	8000TL3-XH	9000TL3-XH	10KTL3-XH	10KTL3-XH BE
AFCI protection	YES				
General data					
Dimensions (W / H / D) in mm	425*387*178mm				
Weight	14kg				
Operating temperature range	-25°C ... +60°C (>45°C Derating)				
Noise emission (typical)	≤29dB(A)				
Altitude	3000m				
Internal consumption at night	<5.5W				
Topology	Transformerless				
Cooling	Natural heat dissipation				
Electronics protection degree	Ip66				
Relative humidity	0~100%				
DC connection	H4/MC4(OPT)				
AC connection	quick connect terminal				
Interfaces					
Display	OLED+LED				
USB/RS485	YES				
WIFI/GPRS/4G/RF/LAN	OPT				

18 Compliance certificates

With the appropriate settings, the unit will comply with the requirements specified in the following standards and directives (dated: Dec./2018):

Model	Certificates
MOD 3-6KTL3-XH MOD 7-10KTL3-XH	CE, IEC 62109, INMETRO, AS 4777.2, En50549, N4105, C10/11, IEC 62116/61727, IEC 60068/61683

19 Contact us

If you have technical questions about our products, please contact the Growatt New Energy Service Hotline. We need the following information to provide you with the necessary help:

- Inverter type
- Inverter serial number
- Inverter error message code
- Inverter OLED display content
- Type and number of PV modules connected to the inverter
- Inverter communication method

Shenzhen Growatt New Energy Co., Ltd

4-13/F, Building A, Sino-German (Europe) Industrial Park,
Hangcheng Ave, Bao'an District, Shenzhen, China

T +86 755 2747 1942

E service@ginverter.com

W www.ginverter.com



Download
Manual



Shenzhen Growatt New Energy Co., Ltd

4-13/F, Building A, Sino-German(Europe) Industrial Park,
Hangcheng Ave, Bao'an District, Shenzhen, China

T +86 755 2747 1942

E service@ginverter.com

W www.ginverter.com

GR-UM-246-A-03